

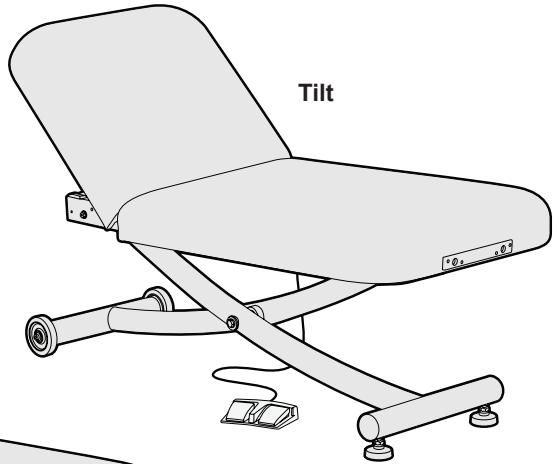

Ellora Vista™ Electric Lift Table



Salon



Tilt

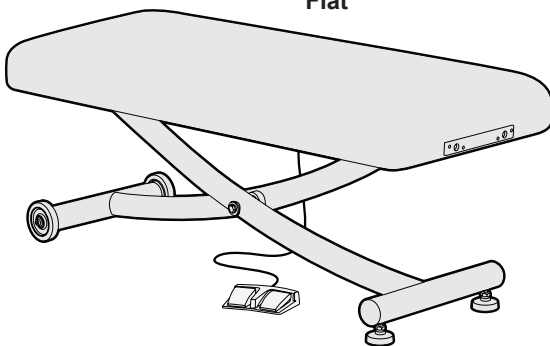

Flat

Legal Notice

The information provided in this document is intended for informational purposes only and is subject to change without notice. The information provided in this document should not be construed as a commitment by Earthlite®.

© Copyright 2019
Earthlite®

All rights reserved. This document or any portion thereof may not be reproduced in any way, including photocopying or translation to another language without the prior written permission from Earthlite®.

Earthlite® is a registered trademark of Earthlite, LLC.

Earthlite® assumes no responsibility for the accuracy or suitability of the information contained in this document. This document may contain technical inaccuracies or errors. Earthlite® makes no expressed or implied warranties of any kind concerning the information contained in this document, including, but not limited to, the implied warranties of merchantability and fitness for purpose.

Earthlite® shall not be liable for incidental or consequential damages in connection with or arising out of the product, performance, or use of this document and the information and material it describes.

Congratulations on your purchase! Earthlite's Ellora Vista™ is perfect for day spas, medi-spas, and resorts. It features a whisper-quiet yet powerful electric lift actuator complete with on-demand height adjustments. This stunningly designed table provides exceptional comfort, function, and years of trouble-free use.

TABLE OF CONTENTS

SAFETY INFORMATION

Safety Symbols	2
Warnings	2-3

Product Overview

Table Specifications	4
----------------------------	---

Section 3: Installation

Table Removal from Shipping Crate	5
Leveling Instructions	6
Placement and Installation	6

Section 4: Operating Instructions

Foot Control Operation	7
Pneumatic Back Tilt Information	8
Pneumatic Leg Break Information	9
Hand Control Operation	10
Table Reset	11
Weight & Lift Capacities	12
Replacing a Foot Glide Leveler	12
Electrical Specifications	13
Accessory Options	13

Section 5: Care & Maintenance

Troubleshooting	14
Care & Maintenance	14
Warranty Information	15
Contact Us	back cover

SAFETY INFORMATION

Safety Symbols

Familiarize yourself with the following Safety & Warning symbols. They are designed to prevent damage and injury to you, your clients, and your new Earthlite product.

IMPORTANT: The important safety instructions and warnings in this manual cannot cover all possible problems and conditions that can occur. Use common sense and caution when installing, operating, or maintaining this appliance.



Indicates an imminently hazardous situation which could result in serious or fatal injury.



Indicates a potentially hazardous situation which could result in serious injury.



Indicates a potentially hazardous situation which could result in equipment damage and/or injury.



RISK OF ELECTRIC SHOCK, FIRE, AND EXPLOSION

- 1) Always unplug this furnishing from the electrical outlet before servicing.
- 2) Never use this furnishing if it has a damaged cord or plug, if it is not working properly, if it has been dropped or damaged, or dropped into water. Return the furnishing to a service center for examination and repair.
- 3) Keep the cord away from heated surfaces.
- 4) Do not use outdoors.
- 5) Do not operate where aerosol (spray) projects are being used or where oxygen is being administered.
- 6) To disconnect, turn all controls to the off position, then remove plug from outlet.
- 7) Connect this furnishing to a properly grounded outlet only. See Grounding Instructions.

GROUNDING INSTRUCTIONS:

POWER SUPPLY: (120V AC grounded) Electrical limitations: Do not use extension cord with this product, plug directly into grounded outlet. **This product must be grounded.** If it should malfunction or breakdown, grounding provides a path of least resistance for electric current to reduce the risk of electric shock. This product is equipped with a cord having an equipment-grounding conductor and a grounding plug. This three prong grounded plug will only fit into wall outlet one way. If the plug does not fit fully in the outlet, contact a qualified electrician to install the proper outlet. Do not change the plug in any way.

NORTH AMERICA ONLY

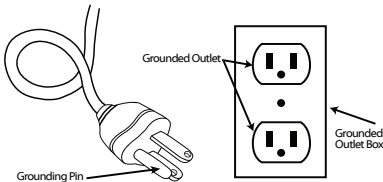

INTERNATIONAL VERSIONS ONLY

This product is for use on a nominal 220V-240V circuit and has a grounding plug (plug type varies by country). Make sure that the product is connected to an outlet having the same configuration as the plug. No adapter should be used with this product.

WARNING

To reduce the risk of burns, fire, electric shock, or injury to persons:

- 1) Use this furnishing only for its intended use as described in these instructions. Do not use attachments not recommended by the manufacturer.
- 2) Do not operate this equipment unless properly trained.
- 3) Install this furnishing in treatment area not accessible to the public.
- 4) Close supervision is necessary when this furnishing is used by, or near children, invalids, or disabled persons.
- 5) This product does not have "pinch point" protection. Only operate when no possibility of any portion of the body could be caught and injured while moving the table top upward/downward, or activating the back/foot tilt.
- 6) Do not use this furnishing to support video equipment such as televisions or computer monitors.
- 7) Never attempt to use the Head or Leg lift section to support concentrated weight such as sitting or standing

CAUTION

1) When lowering any section of the table, make sure that no supplies or any part of yours or your client's body is between the top of your table and its base. This could result in injury, or could damage your table as well as the item. It is recommended that you always return your table top to the lowest flat position to avoid leaving the base exposed.

- 2) When lowering the table height, be sure there are no foreign obstacles are underneath your table that could obstruct it from lowering completely. This could damage your table.
- 3) Never set anything under the table frame to avoid collision if lowered.
- 4) Never operate your table on an uneven surface. Adjust the leveling feet so that your table is stable.
- 5) Never raise the head or leg section with a client in the prone position (face down.)
- 6) Never use or store your table in a wet or very humid environment. Water and excessive moisture can damage the wood cabinet and electrical components. Evidence of exposure to water or moisture will void your warranty.
- 7) If you have purchased the Flexible Armrest Option, never use the Armrests as handholds or body support mechanisms, especially when setting clients on or off the table.
- 8) Never drop or insert any object into any opening.

TABLE SPECIFICATIONS

The Ellora Vista™ is constructed with state of the art materials beginning with a heavy-duty curved steel frame. The upholstered tops are available in three (3) separate variations, Salon, Tilt, and Flat. The Ellora Vista™ was designed with operational simplicity in mind. The height adjustment functionality is controlled by a single foot control. The Salon and Tilt variations of the table are equipped with pneumatic and manual back tilts and leg breaks. There are different mechanisms used on pneumatic assists and manual assists. There is no assembly required for your Ellora Vista™.

The following information lists features, specifications, and options for your stationary massage table:

FEATURES

- Heavy Duty Curved Steel Frame
- Reliable Motor
- Luxuriously Upholstered Top
- Pro-Plush™ Deluxe 3-Layer 3" Cushioning System
- Hands Free Foot Control
- Natursoft™ Upholstery – 100% PU in 14 colors
- ADA Compliant
- Lifetime Limited Warranty on Frame
3 yrs on foam and upholstery
2 yrs on motor and controls

SPECIFICATIONS

- Widths: 28", 30", 32"
- Length: 73"
- Height Range: 18" – 36"
- Lift Capacity: 650 lbs.

OPTIONS

- Non-Electric Pneumatic-Assist (Tilt or Salon Top)
- Extra Foot Pedal
- UltraLeather™ Upholstery
- Flex Arms, Neck Roll and Head Pillow (Salon Top Only)
- Flex-Rest™ or Caress™ Facecradle
- 4" Memory Foam System
- Face Hole (Non-Tilt End Only)
- Deluxe Adjustable Armrests (Non-Tilt End Only)

Salon

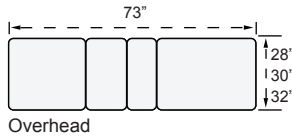
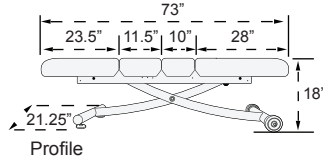
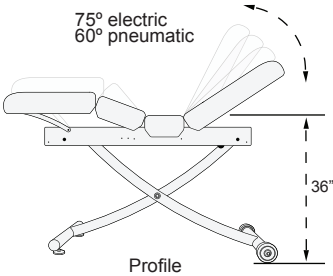

Tilt

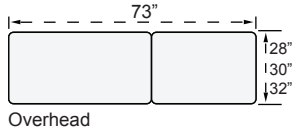
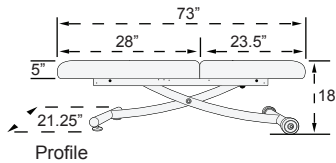
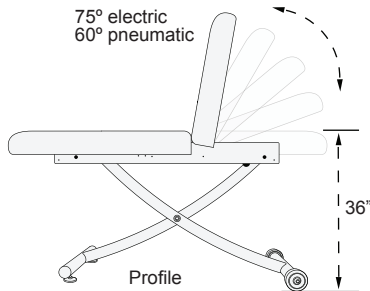

Flat

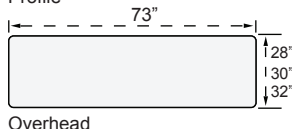
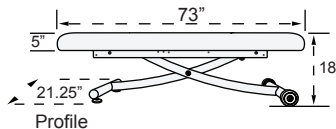
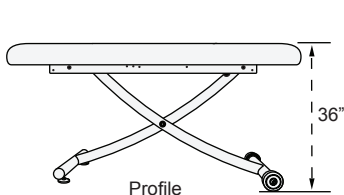

TABLE REMOVAL FROM SHIPPING CRATE

CAUTION

If you did not have your table shipped with 'white glove' service, you may be required to remove your table from its shipping crate. We highly recommend that at least two people conduct the following steps to uncrate the table.

UNPACKING YOUR ELLORA VISTA™ STATIONARY TABLE

The following steps will guide you through carefully removing your Ellora™ Vista Stationary table from the shipping crate. We recommend wearing work gloves during these steps.

Remove the rectangular cardboard lid from the top of the table. Once you have removed the cardboard lid and surrounding cardboard walls from shipping crate, you will find the wheels and foot glide levelers are seated tightly within wood brackets which have been screwed into the plywood base of the shipping crate.

RECOMMENDED TOOLS NEEDED

Work
Gloves



Phillips #1 Screw
Driver

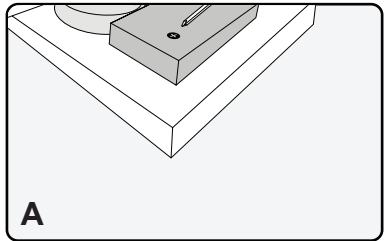
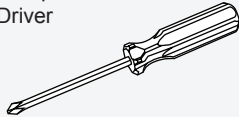

Step 1

With a Phillips #1 screwdriver (or a powered screwdriver), carefully unscrew and remove the two (2) Front facing wood brackets from the plywood base.

(Diagram A)

We recommend removing the two (2) front facing wood brackets (Diagram A) that enclose the foot glide levelers. Do not remove the rear brackets which enclose the rear wheels (Diagram B). These brackets are twice as thick as the front brackets, and will be more difficult to remove.

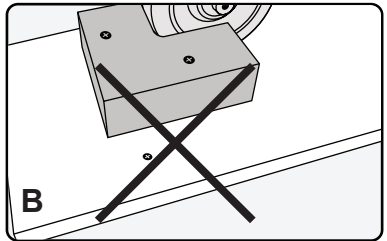

Step 2

Once the front brackets are removed, Carefully pull the Ellora™ Vista straight away from the rear brackets and slide the table onto the floor. We recommend at least two (2) people conduct this step together.

(Diagram C)

It is possible to lift the table directly out of the shipping crate without removing any of the wood brackets, but this is dangerous and not recommended because the weight of the table is at least 200 lbs.

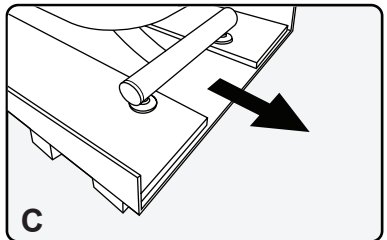

Step 3

Once the table is pulled safely away from the shipping crate, make sure the path from the table to your preferred destination is clear of any obstacles or tripping hazards.

(Diagram D)

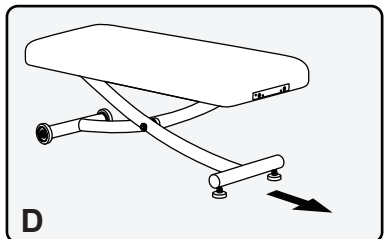

LEVELING THE TABLE

Not all commercial and residential floors are perfectly level. The Ellora™ has foot glide levelers that swivel into place against the floor. If your table is not already level when you remove it from the shipping crate, follow these easy steps to level your table:

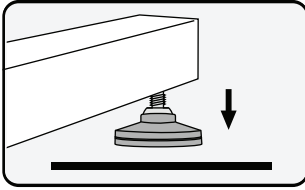

Step 1

Locate which foot glide leveler is not even with the floor.

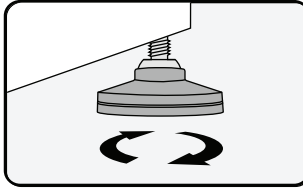

Step 2

Rotate the foot glide leveler clockwise or counter clockwise to bring it to ground level.

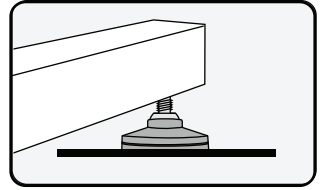

Step 3

Once the foot glide leveler is tight with the floor, apply pressure on top of the table to confirm stability.

PLACEMENT AND INSTALLATION

Once your table is placed safely on the floor, temporarily plug the table into a power outlet and using the foot control, raise the table to waist height, which will make it easier for moving. Once the table is at the desired height, unplug the power cable from the outlet and place the power cable along with the foot control on top of the table to prevent a tripping hazard. For ease of movement and flexibility, your table was built with two (2) rear wheels and two (2) front foot glide levers.

The following steps will guide you through safely moving your table to the desired location. We recommend that at least two (2) people conduct the following steps:

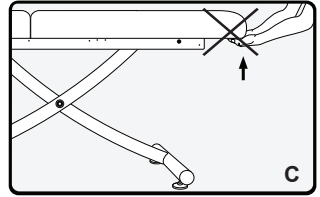
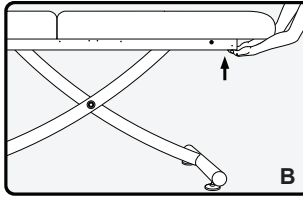
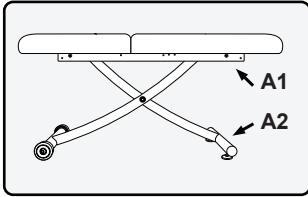

Step 1

Locate the front and rear sections of the table frame underneath the upholstered top as designated by the black arrows above. These are the recommended locations to hold when guiding your table to the desired location (**Diagram A1**).

Note Regarding Step 1:

Locate the front crossbar of the table frame where the foot glide levelers are located (**Diagram A2**). This is a secondary recommended section of the frame to hold if you prefer, but may be more difficult. If you choose this location, properly bend at your knees prior to lifting or pulling the table.

Step 2

Ensure there are no obstacles or tripping hazards in the way and carefully pull the table by the frame into the desired location (**Diagram B**). A second person's assistance is recommended to help push the table from the opposite end.

CAUTION

Do NOT pull or push the table from the upholstered top. Moving the table in this fashion can damage the table and put too much pressure on hinges or other components of the table. Damage made to the table by pulling or pushing on the upholstered top may void the warranty (**Diagram C**).

WARNING

Install this furnishing in treatment area not accessible to the public.
SAFETY ZONE: The treatment area must have 3-ft minimum unobstructed clearance around entire table. Posting a notice is recommended to maintain "Safety Zone Clearance." The designated work area around the table should be clearly marked off.

FOOT CONTROL OPERATION

The Ellora Vista™ comes out of the shipping crate ready to go to work. The foot control is already connected, allowing you to simply raise and lower the table with your feet while your hands remain free to focus on your clients. The left foot pad is designed to lower the table and the right foot pad is designed to raise the table. The height adjustment range of the Ellora Vista™ is 18" at its lowest position and 36" at its highest.

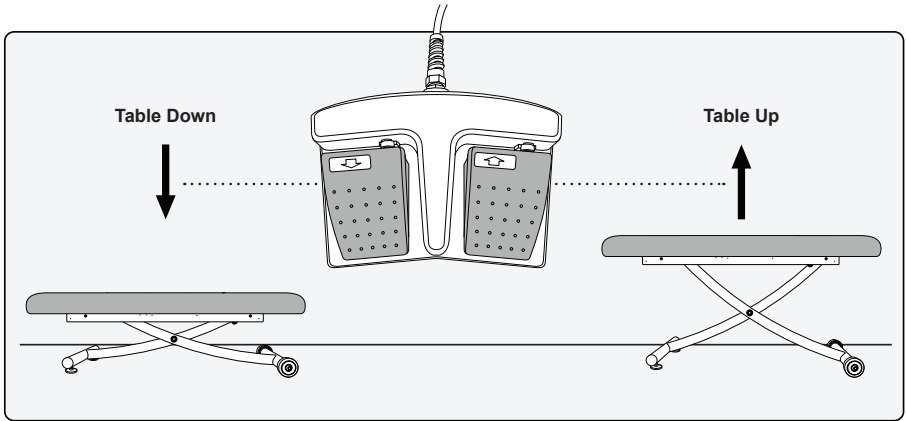

There is no on/off switch on the foot control, so even while the table is not in use, the foot control is still operable. There is a potential for harm or bodily injury when the foot control is being depressed. We recommend unplugging the table from the power outlet when not in use.

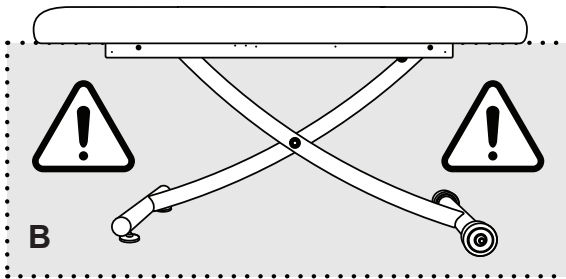

WARNING

The Ellora Vista™ is not equipped with a safety shut off or crush sensor. The area directly underneath the Ellora™ Vista (designated by the space inside the dotted line in **Diagram B**) must remain clear of all objects during operation. Keep small children away from the table at all times.

PNEUMATIC BACK TILT OPERATION

Salon Top & Tilt Top Tables

Pneumatic Ellora Vista™ tables come equipped with a non-electric pneumatic assist mechanism. The following steps will guide you through operating the pneumatic back tilt control and adjusting the back to the desired level:

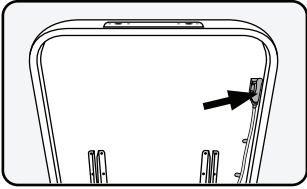

Step 1

Locate the pneumatic back tilt handle, which is located on the right side under the back tilt.

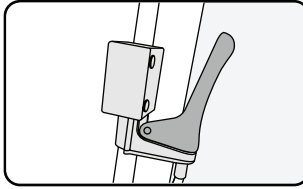

Step 2

The handle is set to the locking position.

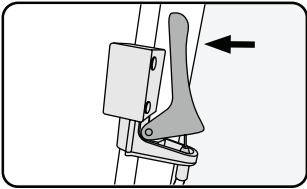

Step 3

Squeeze / press the handle to release the pneumatic assist, which allows you to move the back tilt up or down.

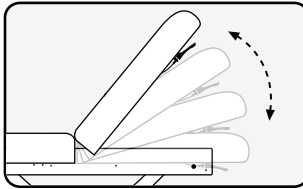

Step 4

With the handle squeezed / pressed, move the back tilt to the desired level and release the handle. It will lock in place.

WARNING

Do Not sit, or put unnecessary amounts of pressure on the back section of the table when it is in tilt position on any level (**Diagram A**). This can damage or destroy the pneumatic assist mechanism for the back section of the table and cause harm or bodily injury to persons. The pneumatic assist mechanism of the table is intended solely to be used when a client is properly seated or laying on top of the table correctly. Damage caused to the table in this manner can void the warranty.

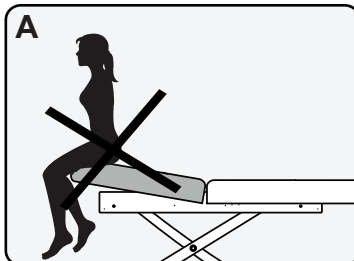

PNEUMATIC LEG BREAK OPERATION

Salon Top Table

Ellora™ Vista Salon tables with the PowerAssist™ option come equipped with the same non-electric pneumatic assist mechanisms as mentioned above. The following steps will guide you through operating the pneumatic leg break control:

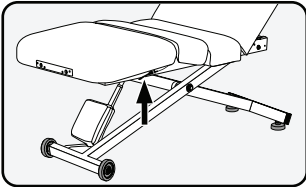

Step 1

Locate the pneumatic leg break control, which is located under the front section of the table.

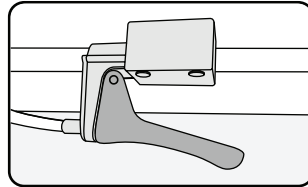

Step 2

The handle is set to the locking position.

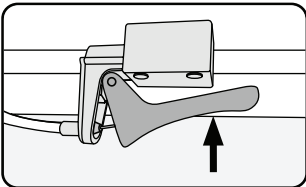

Step 3

Squeeze/press the handle to release the pneumatic assist, which allows you to move the back tilt up or down.

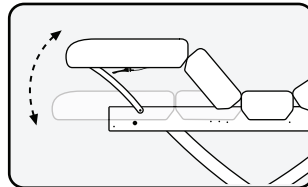

Step 4

With the handle squeezed/pressed, move the back tilt to the desired level and release the handle. It will lock in place.

WARNING

Do Not sit, or put unnecessary amounts of pressure on the leg section of the table when it is in tilt position on any level (**Diagram A**). This can damage or destroy the pneumatic assist mechanism for the leg section of the table and cause harm or bodily injury to persons. The pneumatic assist mechanism of the table is intended solely to be used when a client is properly seated or laying on top of the table correctly. Damage caused to the table in this manner can void the warranty.

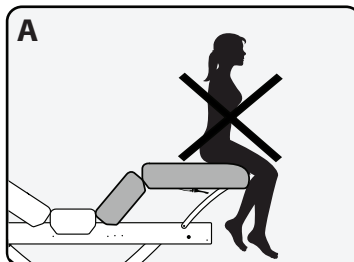

HAND CONTROL OPERATION

Electric Salon Top & Tilt Top Tables

Electric Ellora™ Vista tables come equipped with a convenient hand control for adjusting the back and leg section (if applicable), as well as the table height.. The following steps will guide you through operating the hand control:

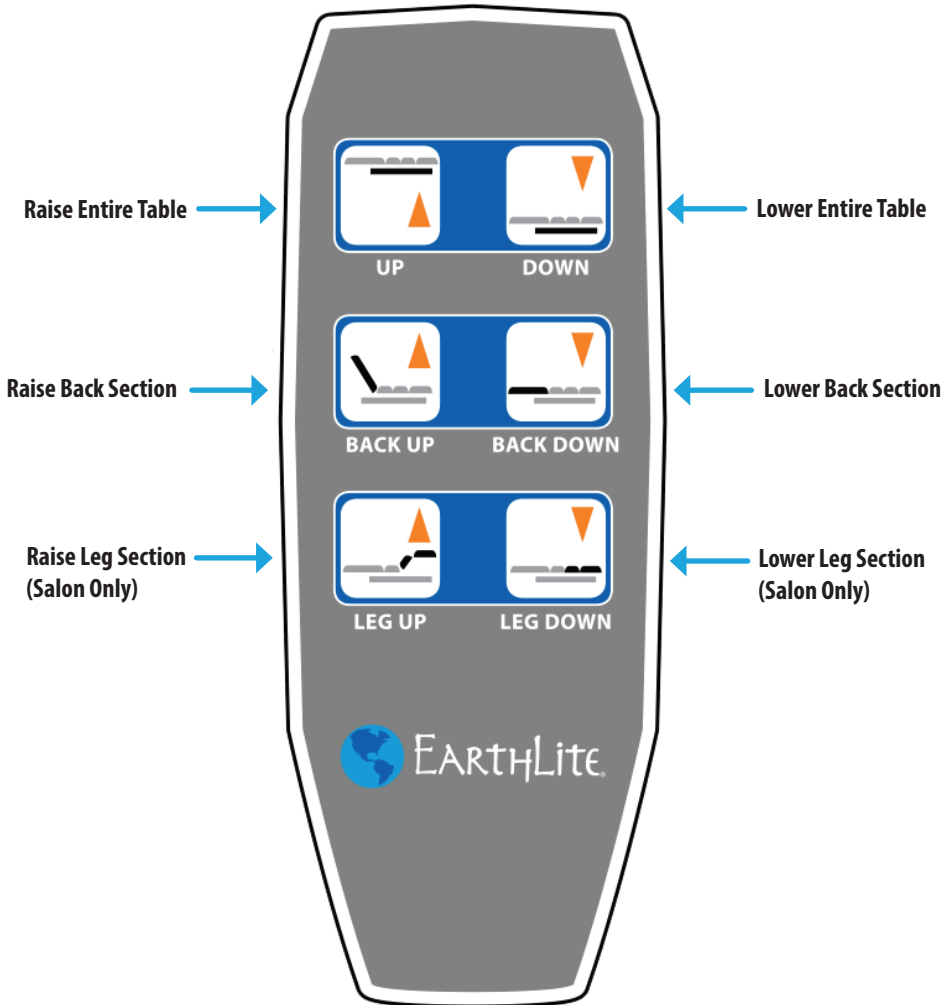

TABLE RESET

Electric Salon Top & Tilt Top Tables

If your electric Ellora™ Vista table is not working properly, it may need to be reset. The following steps will guide you through the reset process:

Step 1

Press and hold the two middle buttons of the second row simultaneously until you hear a series of beeps. **(Diagram A)**

Keep buttons pressed until beeping stops.

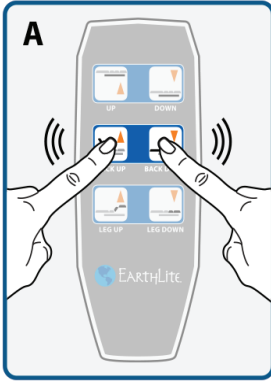

Step 2

Lower back rest down to a flat position. **(Diagram B)**

Keep button pressed until beeping stops.



Step 3

Lower leg section down to a flat position. **(Diagram C)**

Keep button pressed until beeping stops.

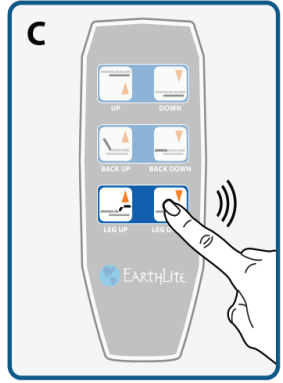

After the back section and leg section are reset and fully retracted to their flat positions (like diagram below), the table will start working normally.

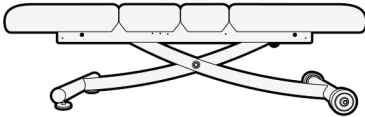

WEIGHT & LIFT CAPACITIES

650 lbs.

The Ellora Vista™ is powered by a heavy-duty, whisper quiet lift actuator to enable easy height adjustment, and positioning. The recommended lift capacity for the Ellora Vista™ massage table is 500 lbs.

50 lbs.

The back rest section of the table, whether pneumatic or electric has a maximum weight capacity of 50 lbs.

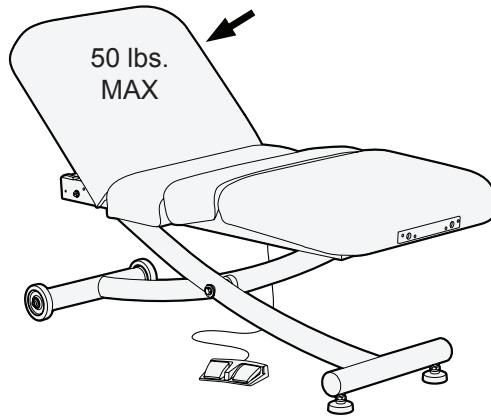

REPLACING A FOOT GLIDE LEVELER

If a foot glide leveler becomes damaged or is in need of replacement, carefully follow these next steps. We recommend that at least two (2) people conduct steps 1 & 5.

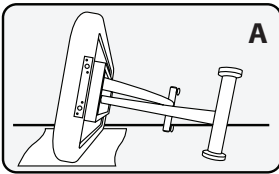

Step 1
Unplug the table and carefully lean the table on its side opposite the foot glide leveler in need of replacement (**Diagram A**).

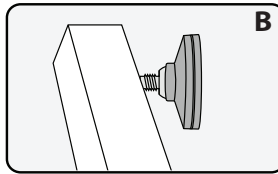

Step 2
Locate the damaged foot glide leveler in need of replacing which is attached to its metal ball joint (**Diagram B**).

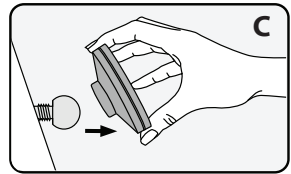

Step 3
Remove the damaged foot glide leveler by pulling it directly off the metal ball joint (**Diagram C**).

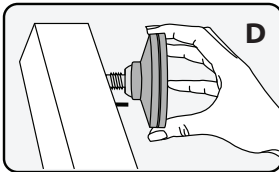

Step 4
Attach the new foot glide leveler to the metal ball joint and push. The Foot glide leveler will snap into place (**Diagram D**).

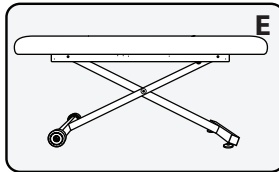





Step 5
Carefully return the table back to its upright position (**Diagram E**).



We recommend at least two (2) people lay the table on its side before conducting step 1 & 5. Lay a towel or blanket down under the table, before resting the table on its side to protect the upholstery.

PLUG DESCRIPTIONS & ELECTRICAL SPECIFICATIONS

China			
PLUG DESCRIPTION			
NORTH AMERICA	UK / MIDDLE EAST	ASIA	EUROPE
 120V AC	 220V AC	 220V AC	 220V AC

Spec	North America	Europe/Asia
Service	120 VAC/60Hz	220 VAC/50Hz
Max Amperage	2.3 Amps	1.4 Amps
Voltage	120VAC	220VAC
Max Consumption	300 Watts	300 Watts

ACCESSORY OPTIONS

Flex-Armrests

The Ellora Vista™ Salon is retrofitted with slots on each side of the table specifically designed to provide a fixed location for Flex-Armrests (Diagram A).

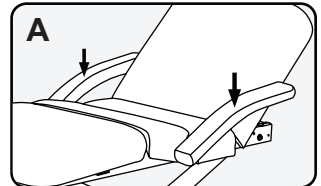
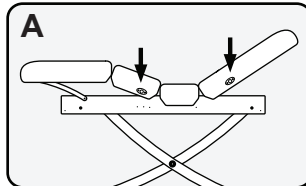

Facecradles & Salon Pillows

All Ellora Vista™ massage tables come with headrest outlets at both ends, specifically designed for providing a fixed location for facecradles and salon pillows (Diagram B).

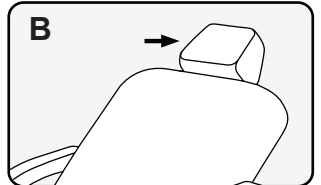
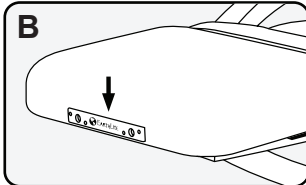

Neck Roll

A neck roll can also be purchased to provide extra comfort for your clients (Diagram C).

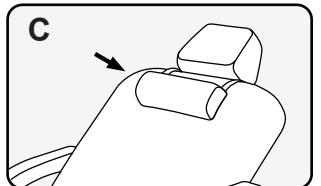

Foot Rest

A Foot Rest will add 10" to the length of your table.

TROUBLESHOOTING

Helpful Tips

This helpful troubleshooting guide will provide you with information about how to recognize a problem with your Ellora Vista™, determine possible causes, and find a solution. In the event your specific situation is not covered in this guide, please contact Earthlite so our technical support department can assist you.

Earthlite Customer Service (760) 599-1112, or (800) 872-0560

Problem	Probable Cause	Solution
My table is wobbling and moving from side to side.	The table is not level with the floor.	Adjust one or both of the foot glide levers until the table becomes level with the floor and is stable.
Table top won't rise or lower. Pneumatic hand lever or finger lever seems stuck.	Cables might be caught or tangled.	Check to see that all the cables are free and not caught on any brackets.
Where can I find my table number?	The customer might be looking on the motor.	The table number is located on the underside of the table, near the head section on a white label. It will read 'SNT' followed by a 6 digit number.
My table is making noise when going up and down.	The center bolt that connects the legs together is too tight.	Remove the plastic cap covering the center bolt and loosen the bolt one half to one full turn.
My table is making a clicking noise and it's not going up or down.	The control box is not relaying the signal from the foot pedal to the actuator.	Replace the control box.
My table is not going up or down and it's not making any sound.	The foot pedal is not relaying signal to the control box.	Replace the foot pedal.

CARE & MAINTENANCE

Perform the following steps as needed for basic maintenance on your Ellora Vista™ massage table and optional accessories. Perform the basic maintenance recommendations for upholstery between client treatments.

Category	Recommendation	Application
Upholstery	Remove day-to-day dirt with a mild soap and warm water solution. For tough stains and to disinfect, use a 15:1 water to bleach solution. Always rinse surface with clean water, and then gently wipe the upholstery. Allow upholstery to air dry before using or storing. Do NOT use Armor All® or citrus-based cleansers. For best results, use only the products suggested above. Alternative cleansing methods may cause serious damage to your table. Such damage would not be covered under the Earthlite warranty program.	<ul style="list-style-type: none"> • Table Bed Surface • Flex-Armrests • Headrest Cushion • Salon Pillow • Bolsters
Steel Table Frame	The powder coated steel frame can be kept clean with a mild detergent and warm water mix. Periodically remove dust from frame with a dry, soft cloth.	<ul style="list-style-type: none"> • Main Steel Frame and Legs
Electronic Components	Anti-static electronic aerosol dusters can be used to keep the surfaces of electronic components, power cables, and plugs free of dust.	<ul style="list-style-type: none"> • Foot Controls • Hand Controls • Motors • Power Cables • Plugs
Lubrication & Mechanical	If necessary, lubricate wheel joints, casters, foot glide levelers, ball joints, and other mechanical parts with a light machine oil. Periodically check table and ensure all bolts remain tightened.	<ul style="list-style-type: none"> • Wheel Joints • Casters • Foot Glide Levelers • Ball Joints, etc.

LIMITED LIFETIME WARRANTY

Absolute Satisfaction Return Policy

If you are not completely satisfied with your Earthlite portable table, chair, or accessory, you may return it within thirty (30) days for a full refund (excluding shipping & handling charges on the original order). Standard stationary and lift tables may be returned within thirty (30) days for a refund (excluding shipping & handling charges on the original order) less a 20% restocking fee. Custom or upgraded products are non-returnable and non-refundable. Proof of purchase is required to obtain RMA (Return Material Authorization) and all returns must be in like-new condition and in the original packaging. Customers will be responsible for all shipping charges.

Warranty Information

Earthlite offers an industry best warranty against defects in materials, design, and workmanship, to the original owner, as follows:

- Frame - lifetime warranty
- Foam and upholstery covering - warranted for three (3) years
- Lift motors, controls, electronics - warranted for two (2) years from the original date of purchase*
- Accessories and options - warranted for one (1) year from the original date of purchase

This warranty does not cover damage caused by normal wear and tear, misuse, accidents, or neglect, which includes tears in the upholstery and damage caused by cleaners. All warranties are limited to repair or replacement at Earthlite's discretion, shipping not included. Proof of purchase is required to obtain RMA (Return Material Authorization) and customers may be required to return defective items. International customers are responsible for all associated return costs (inbound and outbound), as well as any applicable duties and taxes.

*If within these two (2) years, there is a defect, malfunction, or failure of the lift motor or controls, Earthlite will replace or repair the defective component at our discretion; shipping not included. Parts are warranted for 90 days after replacement or 2 years from the original date of table purchase, whichever comes later.

OWNER'S RECORD

Name: _____

Purchase Date: _____

Model No: _____

Serial No: _____

